

Selenkleinstgleichrichter

Kennwerte ($T_a = -40$ bis 40°C)			
Typ	Nennanschlußspannung	Nenngleichstrom	Bauform
	U_{AN} (V)	I_{GN} (mA)	
B 20 C 25	20	25	104
B 20 C 120	20	120	105
B 20 C 400	20	400	102
B 25 C 25	25	25	104
B 25 C 120	25	120	105
B 25 C 400	25	400	102



Bild 102



Bild 104

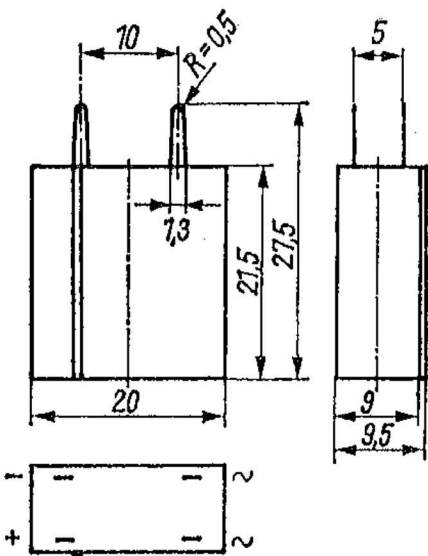
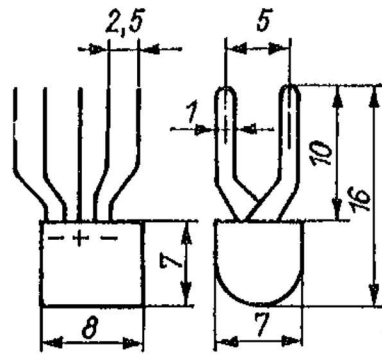
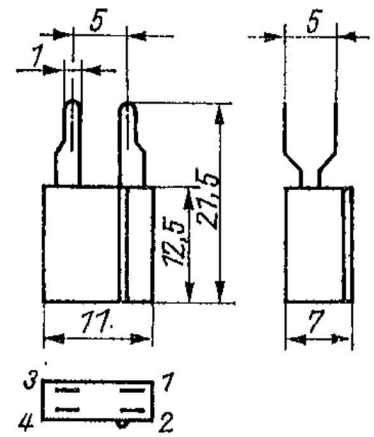

Bild 105